

SQ75-2 80360 L= 205.6 MAX

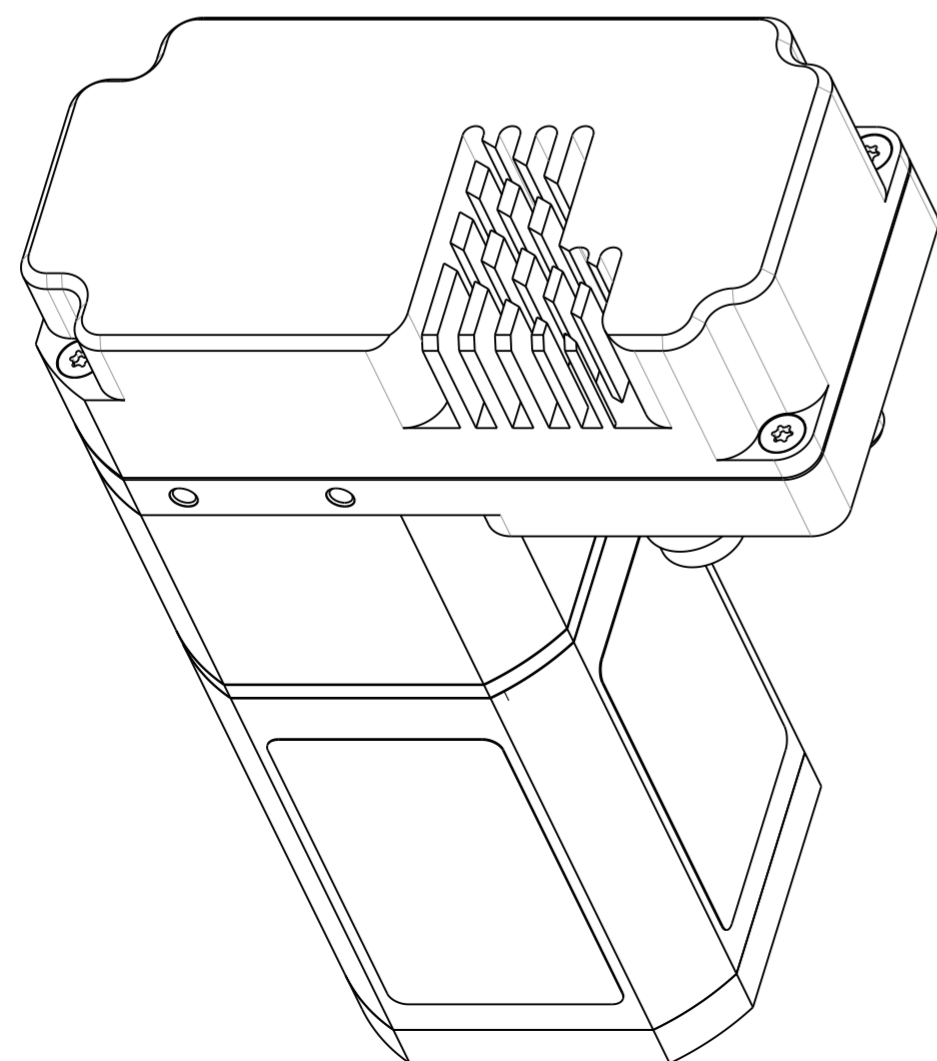

SCALE 3/4

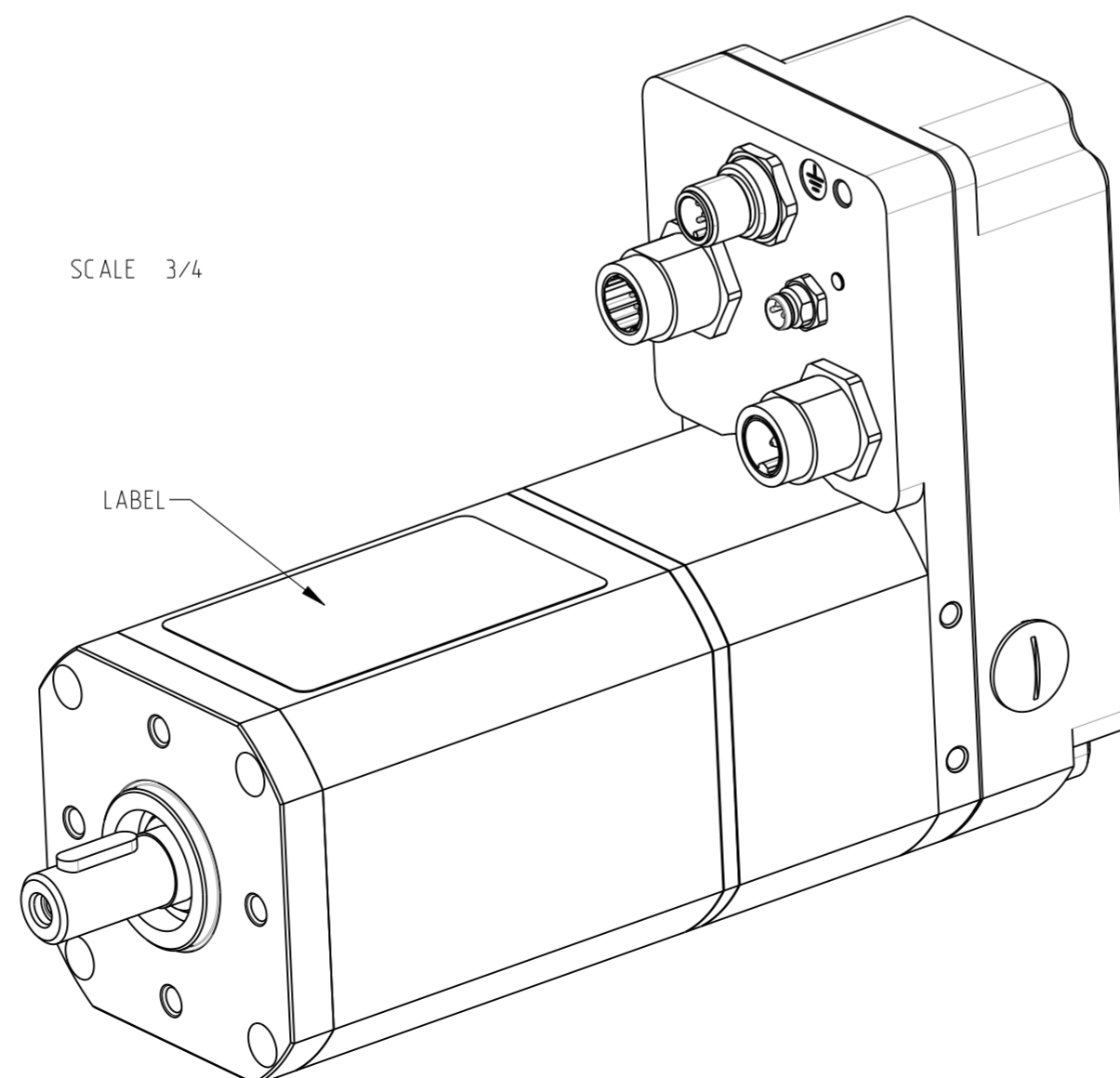

80360101 - V1
CROUZET